



SUZUKA® GROUP



suzuka
malaysia

www.suzuka.com.my
Hotline: 6012-3595 677

TAIWAN • MALAYSIA • THAILAND



Join our photo
contest to win
RM1,000*

*Terms and
Conditions Apply

Details at:
www.suzuka.com.my/
promotion/

KASTPANEL



CONCRETE EFFECT PANEL SERIES

EDITION 2





ABOUT US

SUZUKA® Malaysia belongs to the SUZUKA® Group, which holds manufacturing companies in Taiwan, Malaysia, and Thailand. As one of South East Asia's leading manufacturers in decorative building materials, SUZUKA® Malaysia's expertise in wall finishes dates back to its origins in the town of Suzuka, Japan, after World War II. Specializing in a wide range of stone veneers, waterproofing materials, and textured coatings, we offer durable products that are suitable for decorating and protecting both the interiors and exteriors of your homes and commercial buildings.

Not only do our products cater to buildings of various aesthetics and designs, but they also exceed international quality and safety standards. Armed with protection against UV damage, water seepage, dust, dirt and stains, we lower potential maintenance costs in the future. In addition to being an ISO 9001 certified company, we also carry a selection of SIRIM QAS certified products and a range of environmentally-friendly products certified by Singapore Green Label and SIRIM Eco Label.

Within the past decade, we've become an international supplier to number of regions, including Australia, Saudi Arabia, Thailand, Cambodia, Qatar, the United Arab Emirates, Bahrain, Indonesia, Singapore, and West Africa.

To experience why SUZUKA® products are trusted around the world, choose from our extensive range of coatings and artificial stone veneers.



The KASTPANEL Collection features pre-cast concrete effect panels in a variety of shades, sizes & patterns. Each piece is uniquely crafted to truly mirror the authentic feel and appearance of real, pre-cast cement. Without sacrificing texture, KASTPANELs also manage to be light and compact in nature, rendering them easily transportable and installable. Bringing the stark elegance of exposed concrete to your interior space has never been this easy.

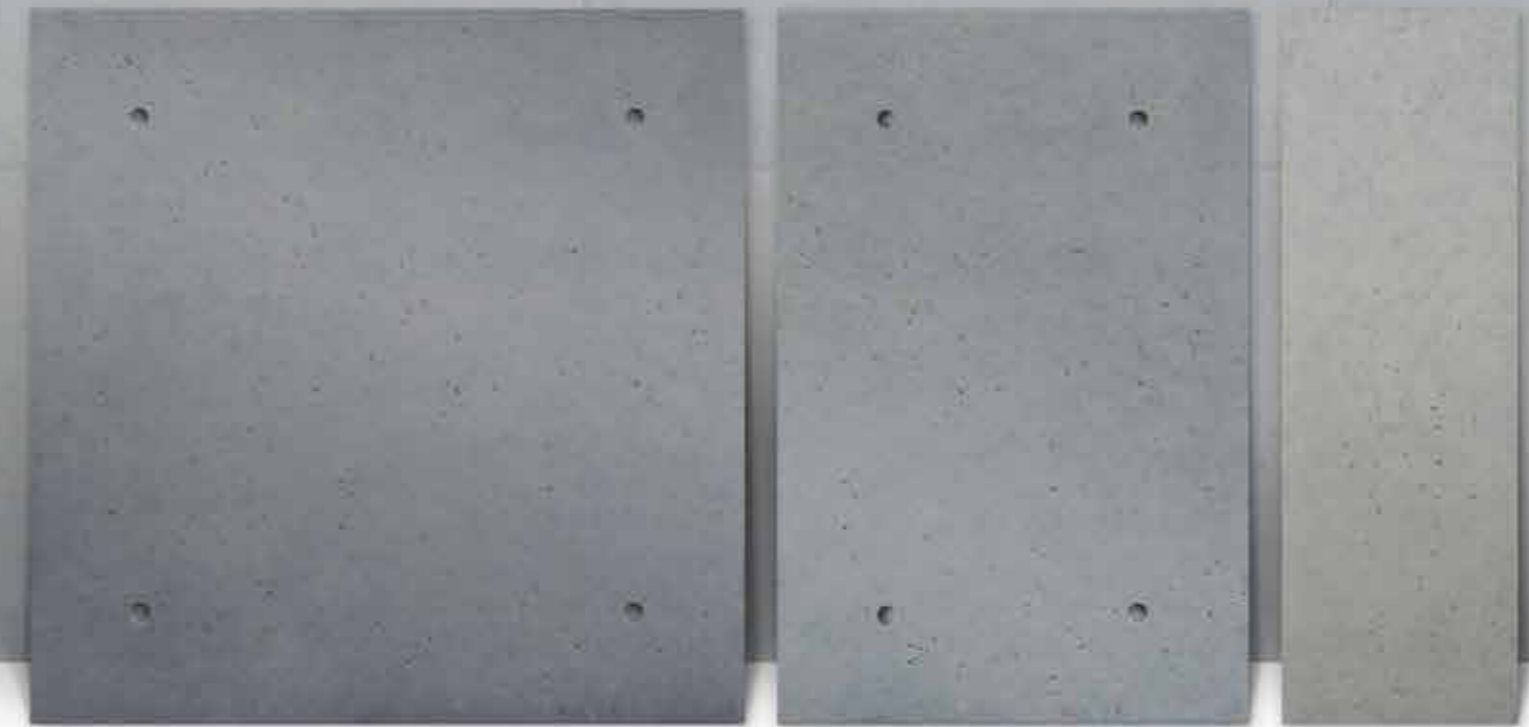

OTHER SUZUKA® PRODUCTS

- Textured Coating
- Brick Veneer
- Artificial Stone Veneer
- Exposed Concrete Effect
- Interior Textured Paint
- Trowel Pebble Stone Coating
- Strato Cement Texture



NOTE:
Colour may vary due to printing and lighting conditions. Please examine product samples prior to ordering. Colour will vary slightly between pieces (Colour Variation: V2).

Size 1

Size: **910 x 910mm**
Thickness: 11mm
Weight: 8.2 - 8.6kg/pc
Packaging: 4pcs/1pc

Colour A

Use with **KASTONE® Grouting GM-11 & 12**



KPC009-A

Colour B

Use with **KASTONE® Grouting GM-11**



KPC009-B

Colour C

Use with **KASTONE® Grouting GM-11**



KPC009-C

Size 2

Size: **600 x 910mm**
Thickness: 11mm
Weight: 5.2 - 5.7kg/pc
Packaging: 6pcs/1pc



KPC006-A



KPC006-B



KPC006-C

Size 3

Size: **300 x 910mm**
Thickness: 11mm
Weight: 2.6 - 3.0kg/pc
Packaging: 10pcs/2pcs



KPC003-A



KPC003-B



KPC003-C

Technical Specifications

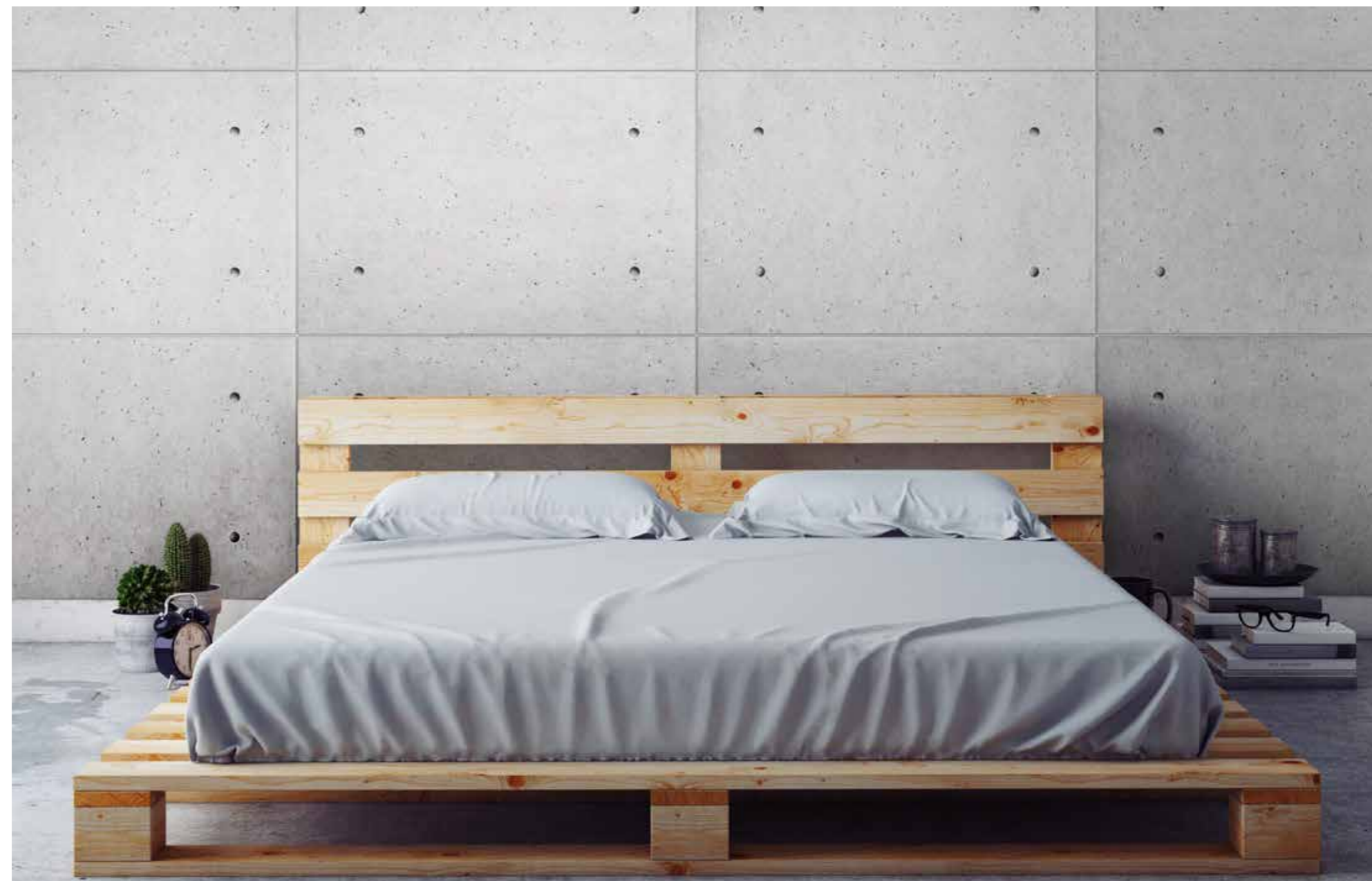



Product Care



UNDER THE ROOF ONLY



For outdoor use, please see our ECES: Concrete Effect Coating Collection

Product Features

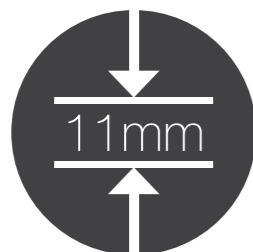

SLIM & COMPACT



QUICK & EASY TO INSTALL



EASY TO CLEAN



LIGHTWEIGHT



ENVIRONMENTALLY FRIENDLY





Installation Instructions

Step 1

Measure the dimensions of your wall (W x H).

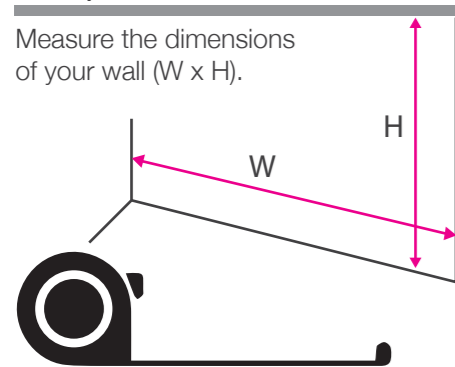

Step 2

Ensure your wall surface is non-wavy, dry, and solid. If your surface is too wavy for the panels to be nailed in flatly, a wooden frame can be built as a backing for the panels.

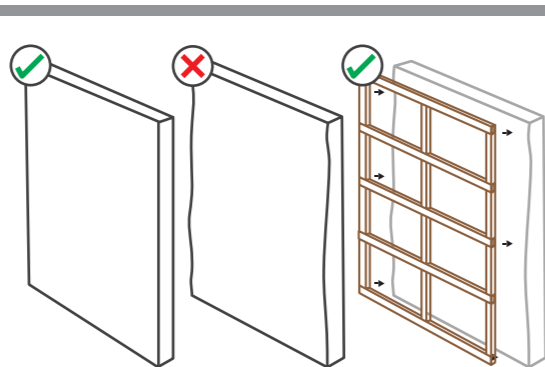

Step 3

Plan the grouting design and panel layout. Pick the size and colour of the panels.



10mm Grouting

Step 4

Some panels may need to be trimmed to fit your wall dimensions.

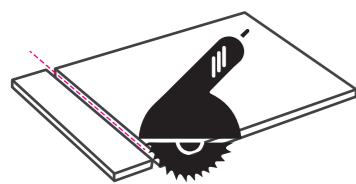

Important Tips:
Always keep your hands clean during trimming and installation.

Step 5

Install the panels working from the bottom upwards. For installation with grouting, the use of spacers and a leveler is recommended.

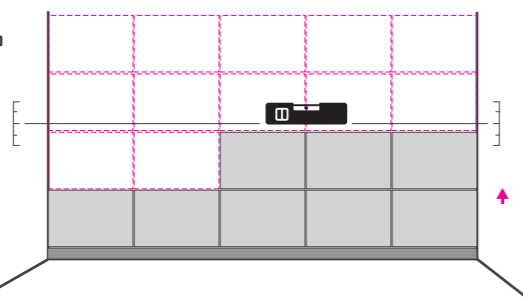

Step 6a

Use a **nail gun** (recommended) or a drill with wall plugs to affix the panels. Ensure the centre and sides of the panels are tightly secured to the wall.

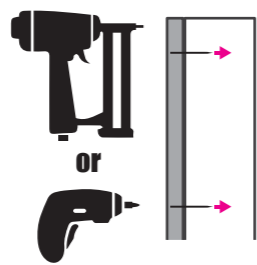

or 6b

Apply **construction adhesive** on the back of the panel and stick to the wall. Hold the board to ensure it is in place, use a spacer to support the grouting.

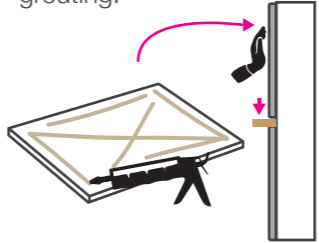

Step 7

Cover the nailed areas and the grouting between the panels with **KASTONE® GROUTING**.

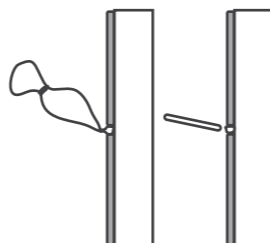

Important !

a. If you wish to secure anything to/on top of these panels, ensure the items are also secured to the existing wall/substrate behind. KASTPANEL is not suitable for supporting external items.

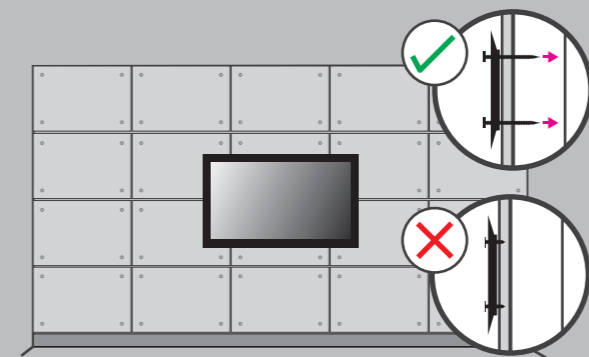

b. KASTPANEL is not suitable for installation on wavy or unstable surfaces.

c. KASTPANEL is not suitable for areas containing high moisture.

d. Do not bend KASTPANELS.

e. KASTPANEL corners are fragile.

f. Do not leave KASTPANELS resting against the wall.



g. KASTPANEL is not suitable for exteriors/outdoors. To find a similar concrete finish for your exteriors, please see our SUZUKA® ECES Collection at www.suzuka.com.my

Managing corners & edges

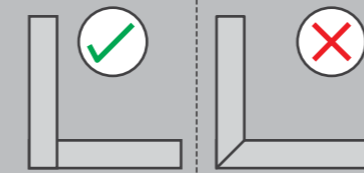

Maintenance

Do not clean panels with liquids. Dusting or wiping with a dry cloth is sufficient.

How to touch up the nail/screw mark?

- 1) Mix the filler with 10-15% water to create a paste.
- 2) Fill the marks with the paste only in indented area, do **NOT** overfill.
- 3) Remove all excess material around the mark with sponge or clean brush.
- 4) Allow the paste to dry for 4 hours.
- 5) Use a small brush to dab the paint onto the area, do **NOT** paint around the area.

Recommended Tools



Recommended Air Nail Gun or Electronic Drill | Circular Saw Tool With a fine diamond blade | Grouting Spacers



Safety Headphones | Protective Gloves | Protective Mask | Protective Glasses



Brush | Ruler | Leveler | Hand Brush

KASTONE® GROUTING



GM-11
Use with Colour A/B/C products.

★CG2
ENHANCED FORMULA



GM-12
Use with Colour A products.