

WALL FINISH PROFESSIONALS

BRICK & STONE VENEER • TEXTURE COATING • WALL PANEL



WIN*
RM 1,000!

Join our photo contest now!

*T&C Apply More info: suzuka.com.my/promotion



suzuka.com.my

  [suzuka.group](https://www.facebook.com/suzuka.group) | Hotline : +6012 - 258 7388

* Photos of the products shown in the brochure are based on the scale of 1:12
* May vary in color due to lighting condition and printing.
We suggest you examine actual product samples before ordering.



STONE-E23-2204



KASTONE®

STONE VENEER COLLECTION



EDITION 23

SUZUKA®

WALL FINISH PROFESSIONALS

SUZUKA® Malaysia belongs to the SUZUKA® Group, which holds manufacturing companies in Taiwan, Malaysia, and Thailand. As one of South East Asia's leading manufacturers in decorative building materials, SUZUKA® Malaysia's expertise in wall finishes dates back to its origins in the town of Suzuka, Japan, after World War II. Specializing in a wide range of stone veneers, waterproofing materials, and textured coatings, we offer durable products that are suitable for decorating and protecting both the interiors and exteriors of your homes and commercial buildings.

Not only do our products cater to buildings of various aesthetics and designs, but they also exceed international quality and safety standards. Armed with protection against UV damage, water seepage, dust, dirt and stains, we lower potential maintenance costs in the future. In addition to being an ISO 9001 certified company, we also carry a selection of SIRIM QAS certified products and a range of environmentally-friendly products certified by Singapore Green Label and SIRIM Eco Label.

Within the past decade, we've become an international supplier to number of regions, including Australia, Saudi Arabia, Thailand, Cambodia, Qatar, the United Arab Emirates, Bahrain, Indonesia, Singapore, and West Africa.

To experience why SUZUKA® products are trusted around the world, choose from our extensive range of coatings and artificial stone veneers.



BRICK & STONE VENEER • TEXTURE PAINTS • KASTANEL • ECES • TEXTURE COATING • PEBBLE STONE COATING

SUZUKA® PRODUCTS

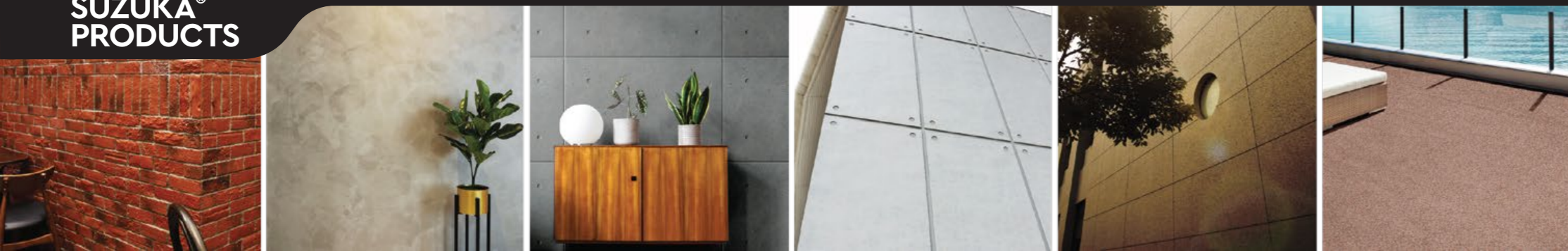

KASTONE®

KASTONE® products range from classic brick styles to timeless stone designs. Our brick and stone veneer collections showcase a wide variety of colours, shapes, and textures, catering to any interior or exterior space.

KASTONE® veneers are authentic in appearance and feel, as each piece is uniquely crafted to mirror natural stones and bricks. Comprised only of premium raw materials, our veneers' lightweight and durable nature streamlines the installation process while minimizing costs and maintenance work.



Corner Brick

Flat Brick





WS-3001



WS-3002



WS-3003



WS-3004



WS-3005

RECOMMENDED INSTALLATION DESIGN

- Arrange the stones in a random pattern.
- Arrange the colors/shades randomly and evenly (you may try laying the stones on the floor first).

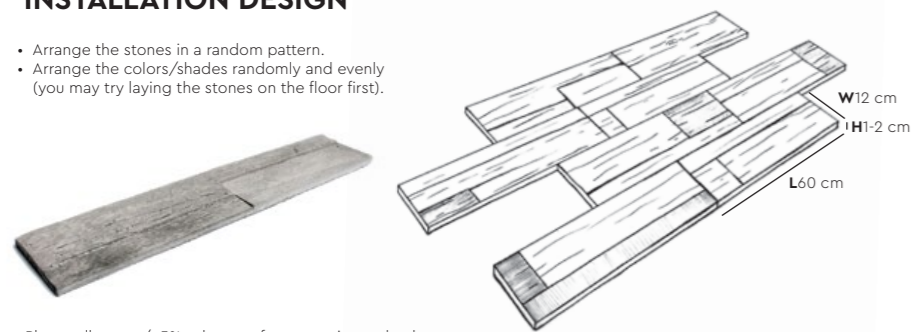

Please allow a +/- 5% tolerance for stone size and colour

WS-300 Coverage (Per Box) : 10.5 ~ 10.7 sqf | Weight (Per Box) : 25.2 kg | Pieces (Per Box) : 14 pcs



KST-1001

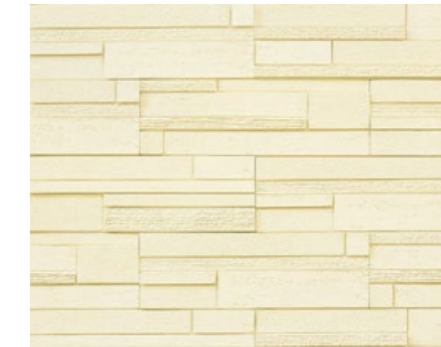

KST-1002



KST-1003A



KST-1004A

RECOMMENDED INSTALLATION DESIGN

- Arrange the stones in a zig zag pattern.
- Arrange the colors/shades randomly and evenly (you may try laying the stones on the floor first).

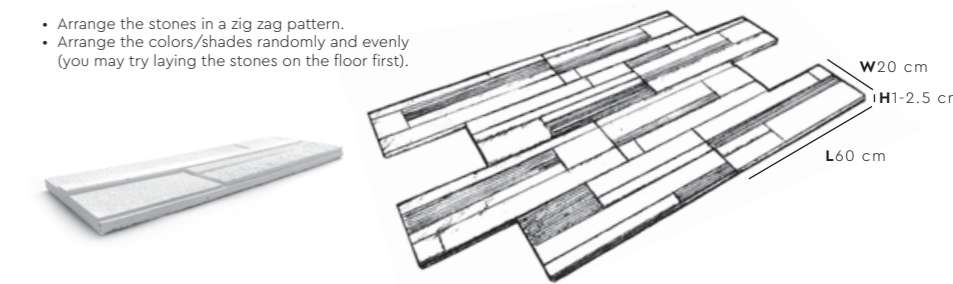

Please allow a +/- 5% tolerance for stone size and colour.

KST-100 Coverage (Per Box) : 7.6 ~ 7.8 sqf | Weight (Per Box) : 22 kg | Pieces (Per Box) : 6 pcs

*May vary in colour due to lighting conditions and printing. Please examine product samples prior to ordering.

*May vary in colour due to lighting conditions and printing. We suggest you examine product samples before ordering.



DS-001



DS-002



DS-003



DS-004

RECOMMENDED INSTALLATION DESIGN

- Arrange the stones in a zig zag pattern.
- Arrange the colors/shades randomly and evenly (you may try laying the stones on the floor first).

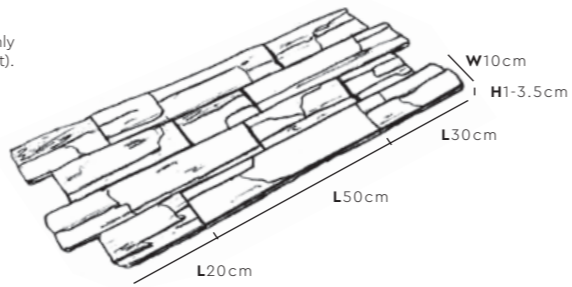

Please allow a +/- 5% tolerance for stone size and colour

DS-00 Coverage (Per Box) : **6.9 ~ 7.6 sqf** | Weight (Per Box) : **23 kg** | Pieces (Per Box) : **14 pcs**



DS-401



DS-402

RECOMMENDED INSTALLATION DESIGN

- Arrange the stones in a zig zag pattern.
- Arrange the colors/shades randomly and evenly (you may try laying the stones on the floor first).

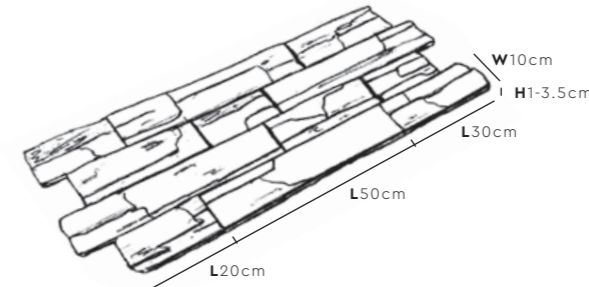
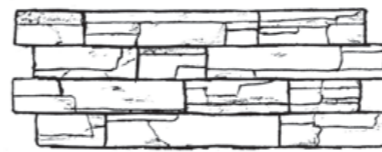

Please allow a +/- 5% tolerance for stone size and colour

DS-40 Coverage (Per Box) : **6.9 ~ 7.6 sqf** | Weight (Per Box) : **23 kg** | Pieces (Per Box) : **14 pcs**



DS-403



DS-301



DS-302



DS-303



DS-304



DS-011



DS-013



DS-015



DS-016

RECOMMENDED INSTALLATION DESIGN

- Arrange the stones in a zig zag pattern.
- Arrange the colors/shades randomly and evenly (you may try laying the stones on the floor first).

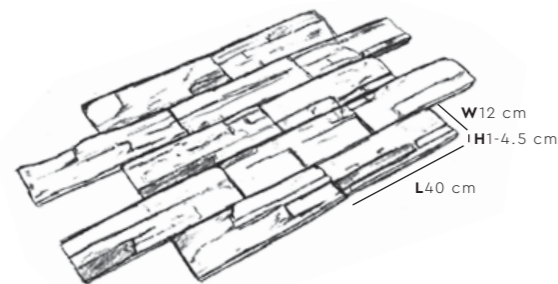

DS-305



DS-306

RECOMMENDED INSTALLATION DESIGN

- Arrange the stones in a zig zag pattern.
- Arrange the colors/shades randomly and evenly (you may try laying the stones on the floor first).

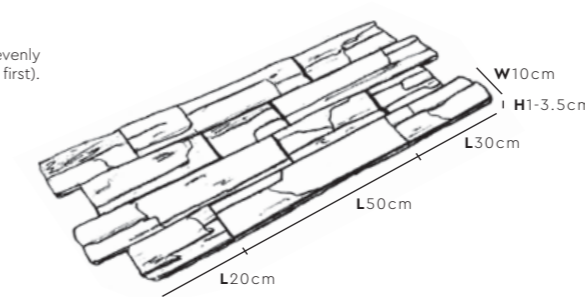

Please allow a +/- 5% tolerance for stone size and colour

DS-01 Coverage (Per Box) : **5.9 ~ 6.5 sqf** | Weight (Per Box) : **21 kg** | Pieces (Per Box) : **12 pcs**



DS-017



DS-018

*May vary in colour due to lighting conditions and printing. We suggest you examine product samples before ordering.

*May vary in colour due to lighting conditions and printing. We suggest you examine product samples before ordering.

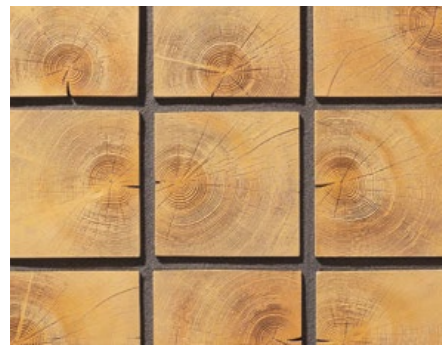

WS-1001



WS-2001

RECOMMENDED INSTALLATION DESIGN

- Arrange the colors/shades randomly and evenly (you may try laying the stones on the floor first).

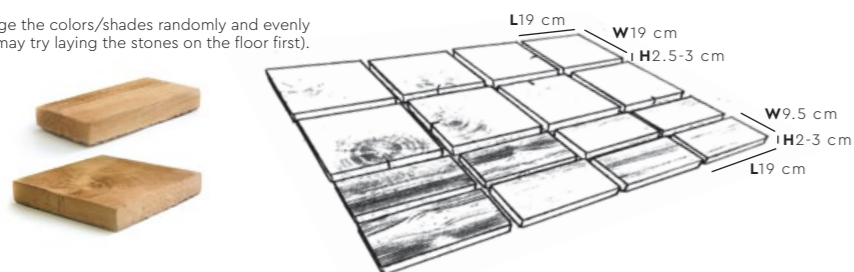

Please allow a +/- 5% tolerance for stone size and colour
The packing coverage and length for WS-100 & WS-200 are inclusive of 1.5cm groove lines

WS-100	Coverage (Per Box) : 4.8 sqf	Weight (Per Box) : 17kg	Pieces (Per Box) : 12 pcs
WS-200	Coverage (Per Box) : 4.6 sqf	Weight (Per Box) : 17kg	Pieces (Per Box) : 24 pcs



DS-801



DS-802



DS-804



DS-805



DS-806



DS-807



DS-808



DS-809

RECOMMENDED INSTALLATION DESIGN

- Arrange the colors/shades randomly and evenly (you may try laying the stones on the floor first).
- Arrange your stones the way you like it. Our stone veneers come in different styles and colours, and can also be customized to fit the size you want.



Please allow a +/- 5% tolerance for stone size and colour

DS-80	Coverage (Per Box) : 10.5 ~ 10.8 sqf	Weight (Per Box) : 32 kg	Pieces (Per Box) : 35 pcs
--------------	---	---------------------------------	----------------------------------

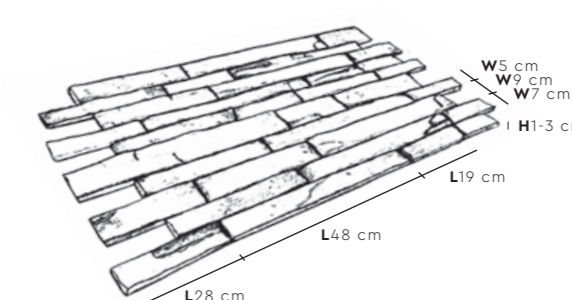
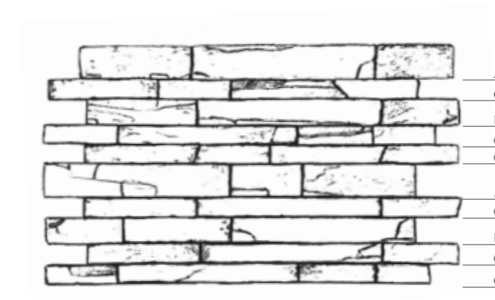

SIZES

A1	: 9.0 x 19.0 cm
A2	: 9.0 x 28.0 cm
A3	: 9.0 x 48.0 cm
B1	: 7.0 x 19.0 cm
B2	: 7.0 x 28.0 cm
B2	: 7.0 x 48.0 cm
C1	: 5.0 x 19.0 cm
C2	: 5.0 x 28.0 cm
C3	: 5.0 x 48.0 cm

*May vary in colour due to lighting conditions and printing. We suggest you examine product samples before ordering.



DS-071



DS-072



DS-073



DS-074



DS-062



DS-201



DS-171

RECOMMENDED INSTALLATION DESIGN

- Arrange the colors/shades randomly and evenly (you may try laying the stones on the floor first).
- Arrange your stones the way you like it. Our stone veneers come in different styles and colours, and can also be customized to fit the size you want.

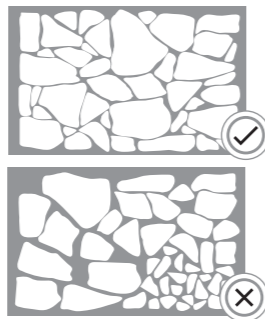
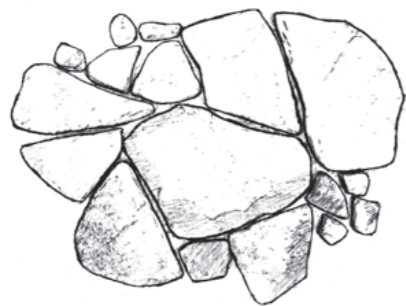

Please allow a +/- 5% tolerance for stone size and colour.
The packing coverage and length for DS-07XX are inclusive of 1cm groove lines

DS-07 Coverage (Per Box) : **5.9 ~ 6.3 sqf** | Weight (Per Box) : **21 kg** | Pieces (Per Box) : **12 ~ 14 pcs**



DS-075

RECOMMENDED INSTALLATION DESIGN

- Arrange the colors/shades randomly and evenly (you may try laying the stones on the floor first).
- Arrange your stones the way you like it. Our stone veneers come in different styles and colours, and can also be customized to fit the size you want.



Please allow a +/- 5% tolerance for stone size and colour.
The packing coverage and length for DS-06XX & DS-17X are inclusive of 1cm groove lines

DS-06 Coverage (Per Box) : **6.3 ~ 6.7 sqf** | Weight (Per Box) : **27 kg** | Pieces (Per Box) : **21 ~ 24 pcs**
DS-17 Coverage (Per Box) : **5.9 ~ 6.3 sqf** | Weight (Per Box) : **22 kg** | Pieces (Per Box) : **24 ~ 27 pcs**



DS-172

RECOMMENDED INSTALLATION DESIGN

- Arrange the colors/shades randomly and evenly (you may try laying the stones on the floor first).
- Arrange your stones the way you like it. Our stone veneers come in different styles and colours, and can also be customized to fit the size you want.

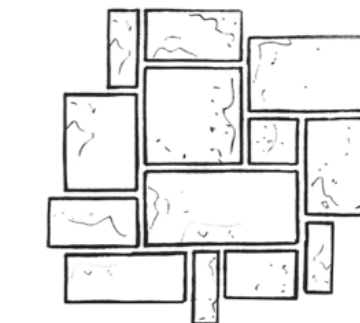

Please allow a +/- 5% tolerance for stone size and colour.

DS-20
Coverage (Per Box) : **6.2 ~ 6.5 sqf** | Weight (Per Box) : **23 kg** | Pieces (Per Box) : **6 ~ 9 pcs**



DS-041



DS-044



DS-045



DS-047



DS-031



DS-034



DS-021



DS-024

RECOMMENDED INSTALLATION DESIGN

- Arrange the colors/shades randomly and evenly (you may try laying the stones on the floor first).
- Arrange your stones the way you like it. Our stone veneers come in different styles and colours, and can also be customized to fit the size you want.



Please allow a +/- 5% tolerance for stone size and colour

DS-04 Coverage (Per Box) : **7.0 ~ 7.4 sqf** | Weight (Per Box) : **22 kg** | Pieces (Per Box) : **17 ~ 21 pcs**

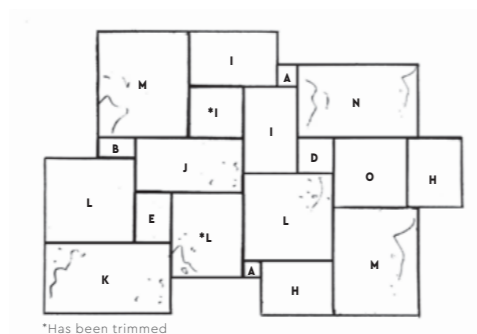

*Has been trimmed

SIZES

A : 4.7 x 4.7 cm	M : 24.5 x 29.0 cm
B : 4.7 x 9.8 cm	N : 19.5 x 29.0 cm
C : 4.7 x 14.5 cm	O : 19.5 x 19.5 cm
D : 9.8 x 9.8 cm	P : 25.0 x 34.5 cm
E : 9.8 x 14.5 cm	Q : 20.0 x 15.0 cm
F : 9.8 x 19.5 cm	R : 20.0 x 35.0 cm
G : 9.8 x 29. cm	S : 15.0 x 15.0 cm
H : 14.5 x 19.5 cm	T : 20.0 x 25.0 cm
I : 14.5 x 24.5 cm	U : 24.0 x 10.0 cm
J : 14.5 x 29.5 cm	V : 24.0 x 24.0 cm
K : 29.0 x 40.0 cm	W : 29.0 x 40.0 cm
L : 29.0 x 29.0 cm	

RECOMMENDED INSTALLATION DESIGN

- Arrange the colors/shades randomly and evenly (you may try laying the stones on the floor first).
- Arrange your stones the way you like it. Our stone veneers come in different styles and colours, and can also be customized to fit the size you want.



Please allow a +/- 5% tolerance for stone size and colour.

DS-03 Coverage (Per Box) : **6.8 ~ 7.2 sqf** | Weight (Per Box) : **26 kg** | Pieces (Per Box) : **19 ~ 23 pcs**

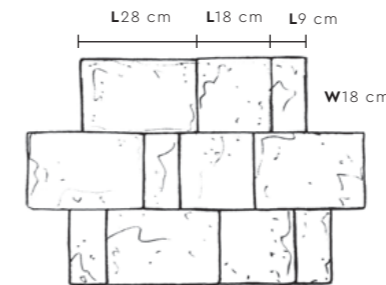

RECOMMENDED INSTALLATION DESIGN

- Arrange the colors/shades randomly and evenly (you may try laying the stones on the floor first).
- Arrange your stones the way you like it. Our stone veneers come in different styles and colours, and can also be customized to fit the size you want.

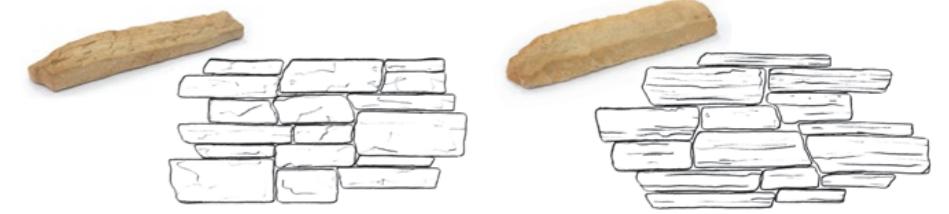

Please allow a +/- 5% tolerance for stone size and colour.

DS-021 Coverage (Per Box) : **6.2 ~ 6.5 sqf** | Weight (Per Box) : **22 kg** | Pieces (Per Box) : **17 ~ 21 pcs**
DS-024 Coverage (Per Box) : **5.8 ~ 6.2 sqf** | Weight (Per Box) : **26 kg** | Pieces (Per Box) : **20 ~ 24 pcs**



DS-111



DS-114



DS-116



DS-117



PS-2001



PS-2002



PS-2004



PS-2005

RECOMMENDED INSTALLATION DESIGN

- Arrange the stones in a zig zag pattern.
- Arrange the colors/shades randomly and evenly (you may try laying the stones on the floor first).

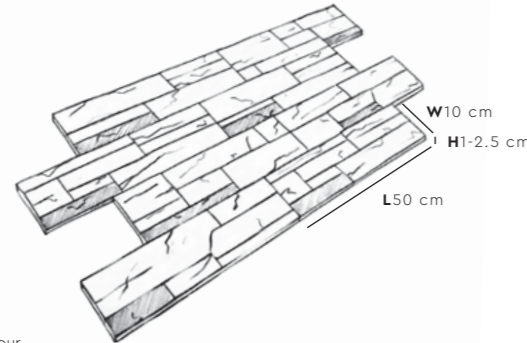

W10 cm

H1-2.5 cm

L50 cm

Please allow a +/- 5% tolerance for stone size and colour.

DS-111 Coverage (Per Box) : **10.5 ~ 10.8 sqf** | Weight (Per Box) : **29 kg** | Pieces (Per Box) : **20 pcs**



DS-118



DS-119

RECOMMENDED INSTALLATION DESIGN

- Arrange the stones in a zig zag pattern.
- Arrange the colors/shades randomly and evenly (you may try laying the stones on the floor first).

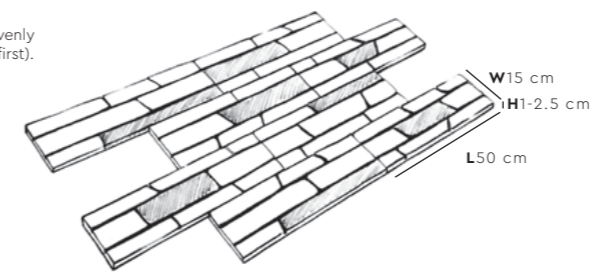

W15 cm

H1-2.5 cm

L50 cm

Please allow a +/- 5% tolerance for stone size and colour.

PS-200 Coverage (Per Box) : **9.4 ~ 9.8 sqf** | Weight (Per Box) : **34 kg** | Pieces (Per Box) : **12 pcs**



PS-2006



DS-701



DS-053

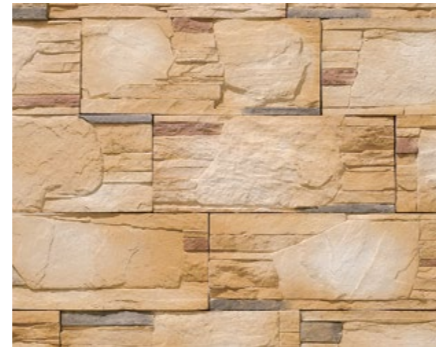

DS-702

RECOMMENDED INSTALLATION DESIGN

- Arrange the colors/shades randomly and evenly (you may try laying the stones on the floor first).
- Arrange your stones the way you like it. Our stone veneers come in different styles and colours, and can also be customized to fit the size you want.



DS-703

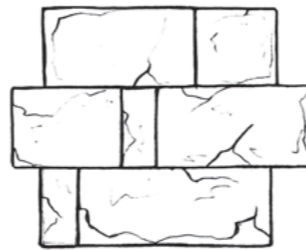

Please allow a +/- 5% tolerance for stone size and colour.

DS-05		
Coverage (Per Box) :	Weight (Per Box) :	Pieces (Per Box) :
7.3 ~ 7.7 sqf	23 kg	14 ~ 18 pcs



DS-601



DS-605



DS-607



DS-608

RECOMMENDED INSTALLATION DESIGN

- Arrange the stones in a zig zag pattern.
- Arrange the colors/shades randomly and evenly (you may try laying the stones on the floor first).

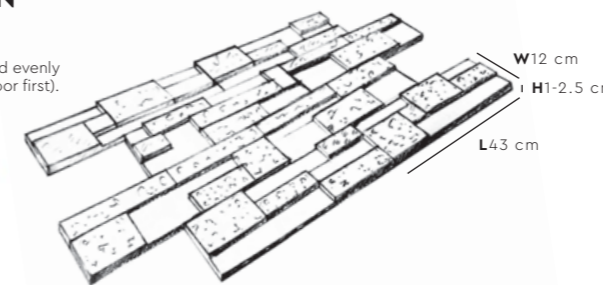

Please allow a +/- 5% tolerance for stone size and colour.

DS-60		
Coverage (Per Box) :	Weight (Per Box) :	Pieces (Per Box) :
6.1 ~ 6.5 sqf	24 kg	12 pcs



DS-609

RECOMMENDED INSTALLATION DESIGN

- Arrange the stones in a zig zag pattern.
- Arrange the colors/shades randomly and evenly (you may try laying the stones on the floor first).

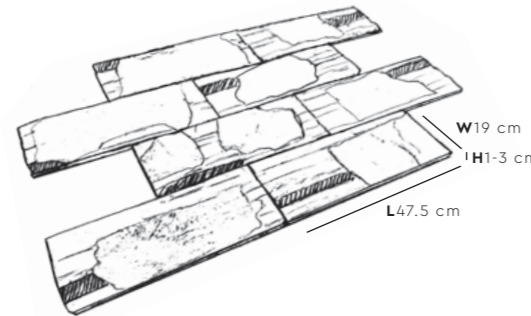

Please allow a +/- 5% tolerance for stone size and colour.

DS-70		
Coverage (Per Box) :	Weight (Per Box) :	Pieces (Per Box) :
10.2 ~ 11.0 sqf	35 kg	12 pcs



DS-091

RECOMMENDED INSTALLATION DESIGN

- Arrange the colors/shades randomly and evenly (you may try laying the stones on the floor first).
- Arrange your stones the way you like it. Our stone veneers come in different styles and colours, and can also be customized to fit the size you want.



Please allow a +/- 5% tolerance for stone size and colour. The packing coverage and length for DS-09XX are inclusive of 1cm groove lines

DS-09 Coverage (Per Box) : **5.9 ~ 6.2 sqf** | Weight (Per Box) : **27 kg** | Pieces (Per Box) : **10 ~ 15 pcs**



DS-093



DS-094



SIZES

- A** : 8.50 x 8.50cm
- B** : 8.50 x 18.0cm
- C** : 8.50 x 28.0cm
- D** : 8.50 x 38.0cm
- E** : 28.0 x 28.0cm
- F** : 28.0 x 18.5cm
- G** : 38.0 x 18.5cm
- H** : 38.0 x 28.0cm
- I** : 18.5 x 18.5cm



DS-081

RECOMMENDED INSTALLATION DESIGN

- Arrange the colors/shades randomly and evenly (you may try laying the stones on the floor first).
- Arrange your stones the way you like it. Our stone veneers come in different styles and colours, and can also be customized to fit the size you want.



Please allow a +/- 5% tolerance for stone size and colour.

DS-08
Coverage (Per Box) : **6.2 ~ 6.6 sqf** | Weight (Per Box) : **26 kg** | Pieces (Per Box) : **20 ~ 24 pcs**

Corner Pieces & Accessories



AS-5201 (L) (44cm x 12cm x 5.5cm)



AS-5201 (M) (44cm x 12cm x 5.5cm)



AS-5201 (R) (44cm x 12cm x 5.5cm)

Recommended Products

KASTONE® Topcoat Stone Care

Topcoat for stone & other masonry surfaces for extra protection and durability.



High Gloss Finish:

An acrylic solvent-based topcoat allowing colour-enhancement and a glossy finish.

Natural Finish:

An environmentally-friendly water-based topcoat that maintains the original color.

Coverage & Packing:

High Gloss			Natural		
1L	4L	18L	1L	5L	18L
75 ~ 108sqf	301 ~ 431sqf	1,356 ~ 1,938sqf	75 ~ 108sqf	377 ~ 538sqf	1,356 ~ 1,938sqf

Suitable for:

- SUZUKA® KASTONE® & Trowel Stone
- Concrete Imprint
- Pebble Wash
- Bricks
- Natural Stone
- Stone / Brick Veneer

* Not recommended for pre-sealed surfaces or non-porous surfaces, such as ceramic tile, marble, granite, porcelain and terrazzo.

Features



Easy Application



UV Resistance



Long Lasting & High Endurance



High Adhesion

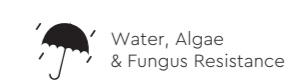

Water, Algae & Fungus Resistance



Stain Resistance & Easy Cleaning



KASTONE® Grouting is a coloured, cementitious and sand-based grouting that is used to fill and support the joints between stones and bricks during installation. Formulated with coarse silica sand, synthetic resin, colour pigments, and water retentive additives, this durable material is applicable on any dry surface with widths between **4-15 mm**.



Coverage & Packing:

Model Code	Coverage (sqf/kg)	Depth (mm)	Width (mm)
DS-02	1.5 ~ 1.7 sqf/kg	0.6 ~ 0.8 cm	Random
DS-06/07	1.4 ~ 1.6 sqf/kg	0.6 ~ 0.8 cm	Random
DS-08	1.5 ~ 1.7 sqf/kg	0.9 ~ 1.1 cm	Random
DS-09/20	1.8 ~ 2.0 sqf/kg	0.8 ~ 1.0 cm	1 cm

Packing Size:

Weight	Packing
3.5 kg / pack	4 packs / box
1.0 kg / pack	14 packs / box

- Features**
- Suitable for both interiors & exteriors
 - Anti-cracking
 - Water-resistant
 - Available in a variety of colours & textures
 - Optimal for the authentic brick wall effect
 - Compressible & expandable (in accordance with environmental factors)

KASTONE® Installation



Step 1 - Wall Surface Preparation

- Hack uniformly across the wall (using a small axe, drill, or hammer) to create a rough and pitted texture on the surface.
- Clean the surface to ensure it is free from dirt and dust.



Step 2 - Mortar Application

Apply a generous layer of mortar across the wall using the notched edge of a trowel, creating a "combed" surface pattern.



Step 3 - Stone Application

• Complete this step starting from the bottom of the wall & moving upwards: Apply a thick layer of mortar onto the back side of a stone. Press the stone firmly onto the mortared wall surface, holding for a few seconds. Repeat this until the section is completed with stones. Use spacers if necessary to ensure a level arrangement.



Step 4 - Cleaning Up

Once the stones are firmly affixed, clean the surface with a dry brush to clear the stones of any dust.



Step 5 - Topcoat Application (Optional)

It is recommended to apply a topcoat layer of either SUZUKA® High Gloss or SUZUKA® Natural Stone Care. This helps enhance the protection of SUZUKA® Stone Veneer against dirt, oil, grease, water stains, fungus, mold and weather conditions.



KASTONE® Packing Data

MODEL	DIMENSION (cm)	FLAT BRICK			CORNER BRICK					
		COVERAGE PER BOX (sqf)	WEIGHT PER BOX (kg)	PIECES PER BOX	DIMENSION (cm)	COVERAGE PER BOX (f)	WEIGHT PER BOX (kg)	PIECES PER BOX	BOXES/PALLET (Flat/Corner)	M ³ /PALLET (Flat/Corner)
DS-17 Series	Random	5.9 ~ 6.3	22	24 ~ 27	-	-	-	-	24 / -	1.00 / -
KST-100 Series	W20 x L60	7.6 ~ 7.8	22	6	-	-	-	-	48 / -	1.14 / -
PS-200 Series	W15 x L50	9.4 ~ 9.8	34	12	-	-	-	-	24 / -	1.34 / -
DS-11 Series	W10 x L50	10.5 ~ 10.8	29	20	-	-	-	-	32 / -	0.9 / -
DS-00 Series	W10 x L20, 30, 50	6.9 ~ 7.6	23	14	W10 x S6 x L15, 25	5.1 ~ 5.3	20	16	32 / 32	1.12 / 1.12
DS-01 Series	W10 x L20, 30, 50	5.9 ~ 6.5	21	12	W10 x S6 x L15, 25	5.1 ~ 5.3	20	16	32 / 32	1.12 / 1.12
DS-40 Series	W10 x L20, 30, 50	6.9 ~ 7.6	23	14	W10 x S6 x L15, 25	5.1 ~ 5.3	20	16	32 / 32	1.12 / 1.12
DS-02 Series	Random	6.2 ~ 6.5	22	17 ~ 21	Random	5.1 ~ 5.3	27	16 ~ 18	24 / 20	1.10 / 1.10
DS-024, 025	Random	5.8 ~ 6.2	26	20 ~ 24	Random	4.8 ~ 5.1	31	16 ~ 18	20 / 20	1.28 / 1.28
DS-30 Series	W12 x L40	7.2 ~ 7.8	27	16	W12 x S10 x L20	6.1 ~ 6.3	26	16	24 / 24	1.28 / 1.28
DS-70 Series	W19 x L47.5	10.2 ~ 11.0	35	12	W19 x S6 x L16	8.3 ~ 8.7	33	14	24 / 24	1.15 / 1.15
DS-03 Series	W18 x L9, 18, 28	6.8 ~ 7.2	26	19 ~ 23	W18 x S6 x L16, 25	4.9 ~ 5.1	18	8	32 / 32	1.12 / 1.12
DS-04 Series	Random	7.0 ~ 7.4	22	17 ~ 21	Random	5.9 ~ 6.1	21	8	24 / 24	1.12 / 1.12
DS-05 Series	W19 x L10, 20, 30, 40, 50	7.3 ~ 7.7	23	14 ~ 18	-	-	-	-	32 / -	1.12 / -
DS-06 Series	Random	6.3 ~ 6.7	27	21 ~ 24	Random	5.1 ~ 5.3	24	12 ~ 16	20 / 20	1.12 / 1.28
DS-07 Series	Random	5.9 ~ 6.3	21	12 ~ 14	Random	5.9 ~ 6.1	21	7 ~ 8	24 / 20	1.10 / 1.28
DS-08 Series	Random	6.2 ~ 6.6	26	20 ~ 24	Random	4.9 ~ 5.1	26	15	24 / 20	1.11 / 1.28
DS-09 Series	Random	5.9 ~ 6.2	27	10 ~ 15	Random	5.1 ~ 5.3	23	12	24 / 20	1.11 / 1.28
DS-20 Series	Random	6.2 ~ 6.5	23	6 ~ 9	-	-	-	-	32 / -	1.10 / -
DS-80 Series	Random	10.5 ~ 10.8	32	35	Random	7.5 ~ 7.8	26	40	24 / 24	1.34 / 1.34
DS-60 Series	W12 x L43	6.1 ~ 6.5	24	12	-	-	-	-	48 / -	1.25 / -
WS-100 Series	W19 x L19	4.8	17	12	-	-	-	-	48 / -	1.05 / -
WS-200 Series	W9.5 x L19	4.6	17	24	-	-	-	-	48 / -	1.05 / -
WS-300 Series	W12 x L60	10.5 ~ 10.7	25.2	14	-	-	-	-	36 / -	1.10 / -
AS-520 Series	W12 x L44	4.3 ~ 4.5	3.5/pc	12	-	-	-	-	- / -	- / -

*Please allow a +/- 5% tolerance for stone size and colour.
*May vary in colour due to lighting conditions and printing. We suggest you examine product samples before ordering.

Calculation of Wall Coverage:

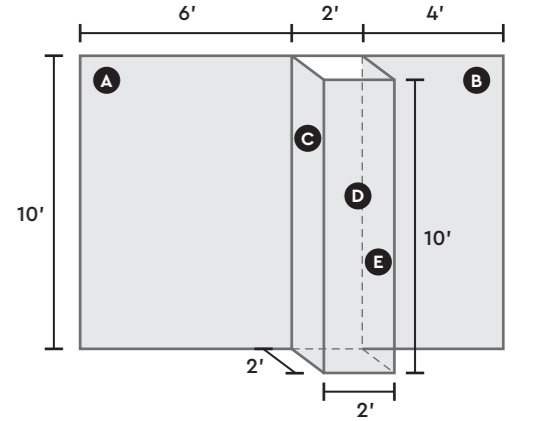

- Surface Dimension:**
- A = 10' x 6' = 60 sqf
 - B = 10' x 4' = 40 sqf
 - C = 10' x 2' = 20 sqf
 - D = 10' x 2' = 20 sqf
 - E = 10' x 2' = 20 sqf
- Total = 160 sqf**

Example for DS-04 Series:

- Flat = 160sqf - 2(10') (height of corners) = 140sqf / 7.4' (coverage per box) = **19 boxes** (estimate total box)
- Corner = 2(10') / 6.1 (coverage per box) = **4 boxes** (estimate total box)

